



# Copa A de Espana Infantil Santiago 2020

Santiago (GAL), 01 Feb 2020

## -38 kg

18 Judoka

POOL A

1 RICO PEDRIDO, Pablo GAL ① RICO PEDRIDO, P. (GAL)

17 9 CALDAS, Afonso POR ② 25 CALVO MARTINEZ, Dario AST

5 PLAZA POLO, Hugo GAL ③ PLAZA POLO, Hugo (GAL)

13 JANISZEWSKI LEMUS, Luca GAL ④ JANISZEWSKI LEMUS, L. (GAL)

POOL B

3 19 BUENO PELAEZ, Ivan GAL ⑤ BUENO PELAEZ, I. (GAL)

11 27 BRICENO GARCIA, Roi GAL ⑥ BRICENO GARCIA, R. (GAL)

7 23 ETCHEVERRIA SERRANO, Jose GAL ⑦ ETCHEVERRIA SERRANO, J. (GAL)

15 31 NAVIA DIEGO, Damian AST ⑧ NAVIA DIEGO, D. (AST)

POOL C

2 18 FERREIRO BOUZAS, Hugo GAL ⑨ FERREIRO BOUZAS, H. (GAL)

10 26 FUENTES ALONSO, Jeronimo AST ⑩ FUENTES ALONSO, J. (AST)

6 22 GONZALEZ ALONSO, Pedro VAL ⑪ GONZALEZ ALONSO, P. (VAL)

14 30 GUTIERREZ INSUA, Hector GAL ⑫ GUTIERREZ INSUA, H. (GAL)

POOL D

4 20 PAREDES AGRELO, Eduardo GAL ⑬ PAREDES AGRELO, E. (GAL)

12 28 TABOADA SUAREZ, Mario AST ⑭ CAETANO, Diogo POR

8 24 VELOSO CENDAL, Javier GAL ⑮ VELOSO CENDAL, J. (GAL)

16 32 PENA RAMOS, Lucas GAL ⑯ PENA RAMOS, L. (GAL)

POOL A Winner / Ganador  
Vainqueur / Sieger

POOL B Winner / Ganador  
Vainqueur / Sieger

POOL C Winner / Ganador  
Vainqueur / Sieger

POOL D Winner / Ganador  
Vainqueur / Sieger

1.

Results	
Résultat / Platzierungen / Resultados	
1.	
2.	
3.	
3.	
5.	
7.	
7.	

Trostrunde / Repechage / Ronda de consolación

Repechage / Trostrunde / Ronda de consolación

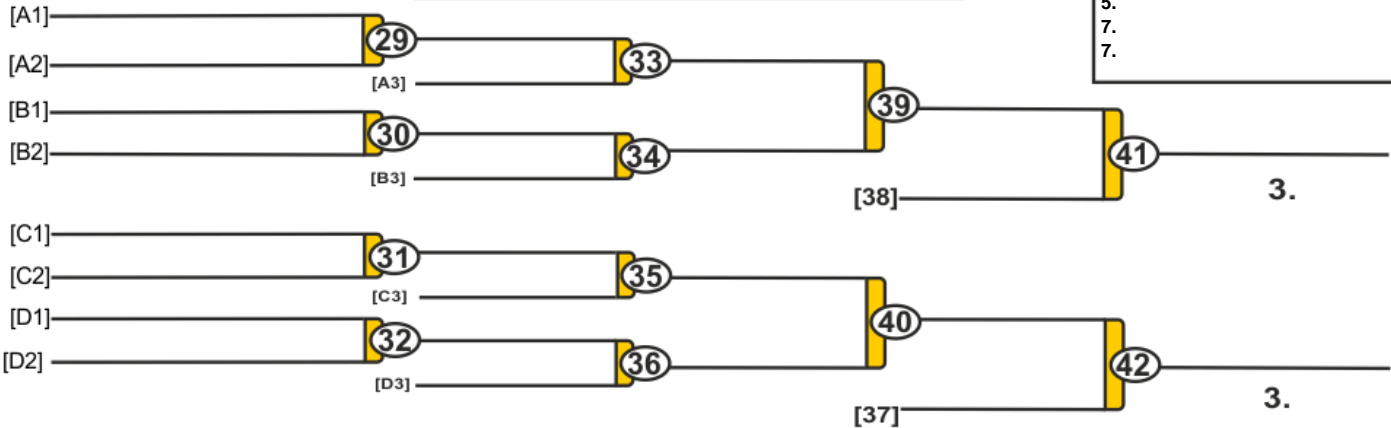



# Copa A de Espana Infantil Santiago 2020

Santiago (GAL), 01 Feb 2020

## -42 kg

30 Judoka

POOL A

1	LYSOGOR CHERKESOV, Maxim	MAD	1	LYSOGOR CHERKESOV, M. (MAD)
17			17	
9	DIAZ PEREZ, Aday	AST	2	
25	CASTRO BALSA, Martin	GAL	25	
5	DAHMANI, Abdella	GAL	3	
21	RICO, Rafael	POR	18	
13	FREIRE ESCRIBANO, Lucas	GAL	4	
29	BLANCO YAGUEZ, Francisco Javier	CLE	4	

POOL B

3	SANTAMARIA GONZALEZ, Lucas	GAL	5	
19	RODRIGUEZ FERNANDEZ, Anxo	GAL	19	
11	VARELA AMOR, Daniel	GAL	6	
27	MADRID GARCIA, Lucas	AST	6	
7	LESTON GARCIA, Ricardo	GAL	7	
23	SANCHEZ CANDANO, Diego	AST	7	
15	SOARES, Isac	POR	8	
31	SOUSA LAVANDEIRA, Breixo	GAL	8	

POOL C

2	MOTA CAMINO, Marco	GAL	9	MOTA CAMINO, M. (GAL)
18			21	
10	CASTRO LOPEZ, Esteban	GAL	10	
26	THEUNISSE, Soy Tony Frans	BAL	10	
6	RODRIGUEZ PENA, Lois	GAL	11	
22	FERNANDEZ FERNANDEZ, Iker	MAD	11	
14	GALINANES OSORIO, Oscar	GAL	12	
30	FERNANDEZ VICENTE, Raul	CLE	12	

POOL D

4	BRIONES CANIBANO, Iosu	CLE	13	
20	MINAMBRES PARDO, Samuel	GAL	13	
12	PORTELA LEIRA, Miguel	GAL	14	
28	ZORRETA, Manuel	POR	14	
8	MONTESINOS NAVALON, Patricio	VAL	15	
24	FRANCO MARTIN, David	GAL	15	
16	PRADO GIGIREY, Alejandro	GAL	16	
32	FERNANDEZ GRANDA, Samuel	AST	16	

POOL A Winner / Ganador  
Vainqueur / Sieger

POOL B Winner / Ganador  
Vainqueur / Sieger

POOL C Winner / Ganador  
Vainqueur / Sieger

POOL D Winner / Ganador  
Vainqueur / Sieger

1.

Results	
Résultat / Platzierungen / Resultados	
1.	
2.	
3.	
5.	
5.	
7.	
7.	

Trostrunde / Repechage / Ronda de consolación

Repechage / Trostrunde / Repêchage

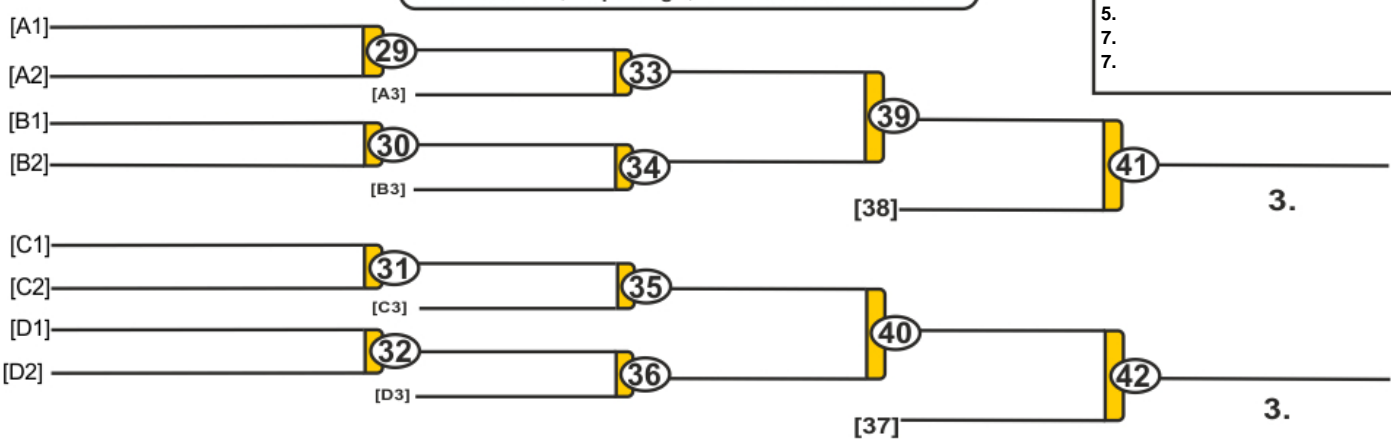



# Copa A de Espana Infantil Santiago 2020

Santiago (GAL), 01 Feb 2020

## -46 kg

20 Judoka

POOL A

1	VAZQUEZ MORANDEIRA, Tomas	GAL	1	VAZQUEZ MORANDEIRA, T. (GAL)
17			17	
9	IGLESIAS BLANCO, Pedro	GAL	2	IGLESIAS BLANCO, P. (GAL)
25			25	
5	PEREZ ANTON, Patricio	VAL	3	
21	GARCIA RODRIGUEZ, Abel	GAL	18	
13	MARTINEZ SAVEEDRA, Daniel	AST	4	MARTINEZ SAVEEDRA, D. (AST)
29			29	

POOL A Winner / Ganador  
Vainqueur / Sieger

POOL B

3	PENAS MERINO, Unai	GAL	5	PENAS MERINO, U. (GAL)
19			19	
11			6	FERNANDEZ GOMEZ, I. (GAL)
27	FERNANDEZ GOMEZ, Iago	GAL	20	
7	CORDERO GLEZ, Alejandro	AST	7	CORDERO GLEZ, A. (AST)
23			20	
15	LOPEZ LOIRA, Miguel	GAL	8	
31	RUIZ PEREZ, Diego	EXT	8	

POOL B Winner / Ganador  
Vainqueur / Sieger

POOL C

2	FLORES RIPALDA, Jose Antonio	MAD	9	FLORES RIPALDA, J. (MAD)
18			21	
10	FUENTES PEDREIRA, Sergio	GAL	10	FUENTES PEDREIRA, S. (GAL)
26			21	
6			11	EL ARJOUNI, W. (BAL)
22	EL ARJOUNI, Wassim	BAL	22	
14	FERNANDEZ ESCANO, Marcos	AST	12	
30	OLIVES MALLO, Bregan	GAL	12	

POOL C Winner / Ganador  
Vainqueur / Sieger

POOL D

4	LEMO TOLEDO, Joao Vitor	MAD	13	LEMO TOLEDO, J. (MAD)
20			23	
12	YUSTE LUGILDE, Jairo Jose	GAL	14	
28	ALVAREZ FERNANDEZ, Juan Carlo	AST	23	
8	LAGO GONZALEZ-SIERRA, Luis	GAL	15	LAGO GONZALEZ-SIERRA, L. (GAL)
24			24	
16	OLMO ESTEVEZ, Nicolas	EXT	16	
32	GUTIERREZ BARBEITO, Inigo	GAL	16	

POOL D Winner / Ganador  
Vainqueur / Sieger

1.

43

### Results

Résultat / Platzierungen / Resultados

- 1.
- 2.
- 3.
- 3.
- 5.
- 5.
- 7.
- 7.

### Trostrunde / Repechage / Ronda de consolación

Repechage / Trostrunde / Ronda de consolación

[A1]		29		33		
[A2]						
[B1]						
[B2]		30		34		41
			[B3]			
					[38]	3.
[C1]						
[C2]		31		35		
			[C3]			
[D1]						
[D2]		32		36		42
			[D3]			
					[37]	3.





# Copa A de Espana Infantil Santiago 2020

Santiago (GAL), 01 Feb 2020

## -50 kg

17 Judoka

POOL A

1 QUEREDA YUDICE, Hugo GAL ① QUEREDA YUDICE, H. (GAL)

17 [ ] ①

9 RIBEIRO, Dinis POR ② RIBEIRO, Dinis (POR)

25 [ ] ②

5 [ ] ③ ROCHA MIRANDA, M. (GAL)

21 ROCHA MIRANDA, Mateo GAL ③ ①

13 [ ] ④ PONTE BARCA, R. (GAL)

29 PONTE BARCA, Raul GAL ④ ②

POOL B

3 GONZALEZ LOPEZ, Mauro GAL ⑤ GONZALEZ LOPEZ, M. (GAL)

19 [ ] ⑤

11 SOUTO BRENLLA, Anxo GAL ⑥ SOUTO BRENLLA, A. (GAL)

27 [ ] ⑥

7 GAMBA ANTUNA, Alvaro AST ⑦ GAMBA ANTUNA, A. (AST)

23 [ ] ⑦

15 MANCERA DIAZ, Jose EXT ⑧

31 GARCIA SANCHEZ, Daniel GAL ⑧

POOL C

2 FERNANDEZ DONAIRE, Gonzalo AST ⑨ FERNANDEZ DONAIRE, G. (AST)

18 [ ] ⑨

10 TENREIRO LEIRA, Mario GAL ⑩ TENREIRO LEIRA, M. (GAL)

26 [ ] ⑩

6 CUBREIRO MORENO, Manuel GAL ⑪ CUBREIRO MORENO, M. (GAL)

22 [ ] ⑪

14 [ ] ⑫ DEVESA SALGADO, D. (GAL)

30 DEVESA SALGADO, Daniel GAL ⑫

POOL D

4 CARAZO LACUNZA, Julio MAD ⑬ CARAZO LACUNZA, J. (MAD)

20 [ ] ⑬

12 [ ] ⑭ BLANCO MARIA, J. (GAL)

28 BLANCO MARIA, Jesus GAL ⑭

8 GANDARA CARRERA, Carlos GAL ⑮ GANDARA CARRERA, C. (GAL)

24 [ ] ⑮

16 [ ] ⑯ TATO FERNANDEZ, S. (GAL)

32 TATO FERNANDEZ, Samuel GAL ⑯

Repechage / Trostrunde / Repêchage

Trostrunde / Repechage / Ronda de consolación

[A1] [ ] ⑲ [A2] [ ] ⑳

[B1] [ ] ㉑ [B2] [ ] ㉒

[C1] [ ] ㉓ [C2] [ ] ㉔

[D1] [ ] ㉕ [D2] [ ] ㉖

[A3] [ ] ㉗ [B3] [ ] ㉘

[C3] [ ] ㉙ [D3] [ ] ㉚

[ ] ㉛ [ ] ㉜ [ ] ㉝ [ ] ㉞ [ ] ㉟ [ ] ㊱ [ ] ㊲ [ ] ㊳ [ ] ㊴ [ ] ㊵ [ ] ㊶ [ ] ㊷ [ ] ㊸ [ ] ㊹ [ ] ㊺ [ ] ㊻ [ ] ㊼ [ ] ㊽ [ ] ㊾ [ ] ㊿

POOL A Winner / Ganador  
Vainqueur / Sieger

POOL B Winner / Ganador  
Vainqueur / Sieger

POOL C Winner / Ganador  
Vainqueur / Sieger

POOL D Winner / Ganador  
Vainqueur / Sieger

1.

Results

Résultat / Platzierungen / Resultados

- 1.
- 2.
- 3.
- 3.
- 5.
- 5.
- 7.
- 7.

3.

3.



# Copa A de Espana Infantil Santiago 2020

Santiago (GAL), 01 Feb 2020

## -55 kg

27 Judoka

POOL A

1	INFANZON OCAMPO, Carlos	GAL	1	INFANZON OCAMPO, C. (GAL)
17			17	
9	BLANCO MOSQUERA, Daniel	GAL	2	
25	CUETO GONZALEZ, Manuel	AST	25	
5	VILA TOBIO, Nicolas	GAL	3	
21	CARRASCO CONDE, Javier	GAL	18	
13	CASTANON NOGUEIRA, Nicolas	GAL	4	
29	CES ROJAS, Gabriel Aaron	EXT	4	

POOL A Winner / Ganador  
Vainqueur / Sieger

POOL B

3	VILASECO NOVOA, Mario	GAL	5	VILASECO NOVOA, M. (GAL)
19			19	
11	DOS SANTOS NEBRA, Aitor	GAL	6	
27	GARCIA MAYO, Roberto	GAL	6	
7	BUDIA CRIADO, Roman	MAD	7	BUDIA CRIADO, R. (MAD)
23			20	
15	GRANDE GOMEZ, Roi	GAL	8	
31	TURCHETTI GIMENO, Simon	VAL	8	

POOL B Winner / Ganador  
Vainqueur / Sieger

POOL C

2	PARRILLA MUNOZ, Daniel	GAL	9	PARRILLA MUNOZ, D. (GAL)
18			21	
10	LARROSA FERNANDEZ, Dario	GAL	10	
26	BORDA GALINDO, Aimar	VAS	10	
6	TAMARGO ALVAREZ, Lucas	AST	11	
22	RODRIGUEZ FARALDO, Mateo	GAL	22	
14	SANCHEZ ALVAREZ, Enzo	AST	12	
30	RODRIGUEZ FERNANDEZ, Marco	GAL	12	

POOL C Winner / Ganador  
Vainqueur / Sieger

POOL D

4	VIZCAINO BRAVO, Teo	VAL	13	VIZCAINO BRAVO, T. (VAL)
20			23	
12	RODRIGUEZ GONZALEZ, Alvaro	GAL	14	
28	SENIN ARES, Bruno	GAL	14	
8	RODRIGUEZ FERRERO, Marti	VAL	15	
24	SILVA CARBAJALES, Xose	GAL	24	
16	ROMERO GONZALO, Jose Luis	EXT	16	
32	VILA VILLARES, David	GAL	16	

POOL D Winner / Ganador  
Vainqueur / Sieger

1.

43

Results	
Résultat / Platzierungen / Resultados	
1.	
2.	
3.	
5.	
5.	
7.	
7.	

Trostrunde / Repechage / Ronda de consolación

Repechage / Trostrunde / Ronda de consolación

[A1]	29	33		
[A2]				
[B1]		[A3]	39	
[B2]	30	34		41
		[B3]	[38]	
[C1]	31	35		
[C2]		[C3]		
[D1]	32	40		
[D2]		[D3]	42	
			[37]	

3.

3.



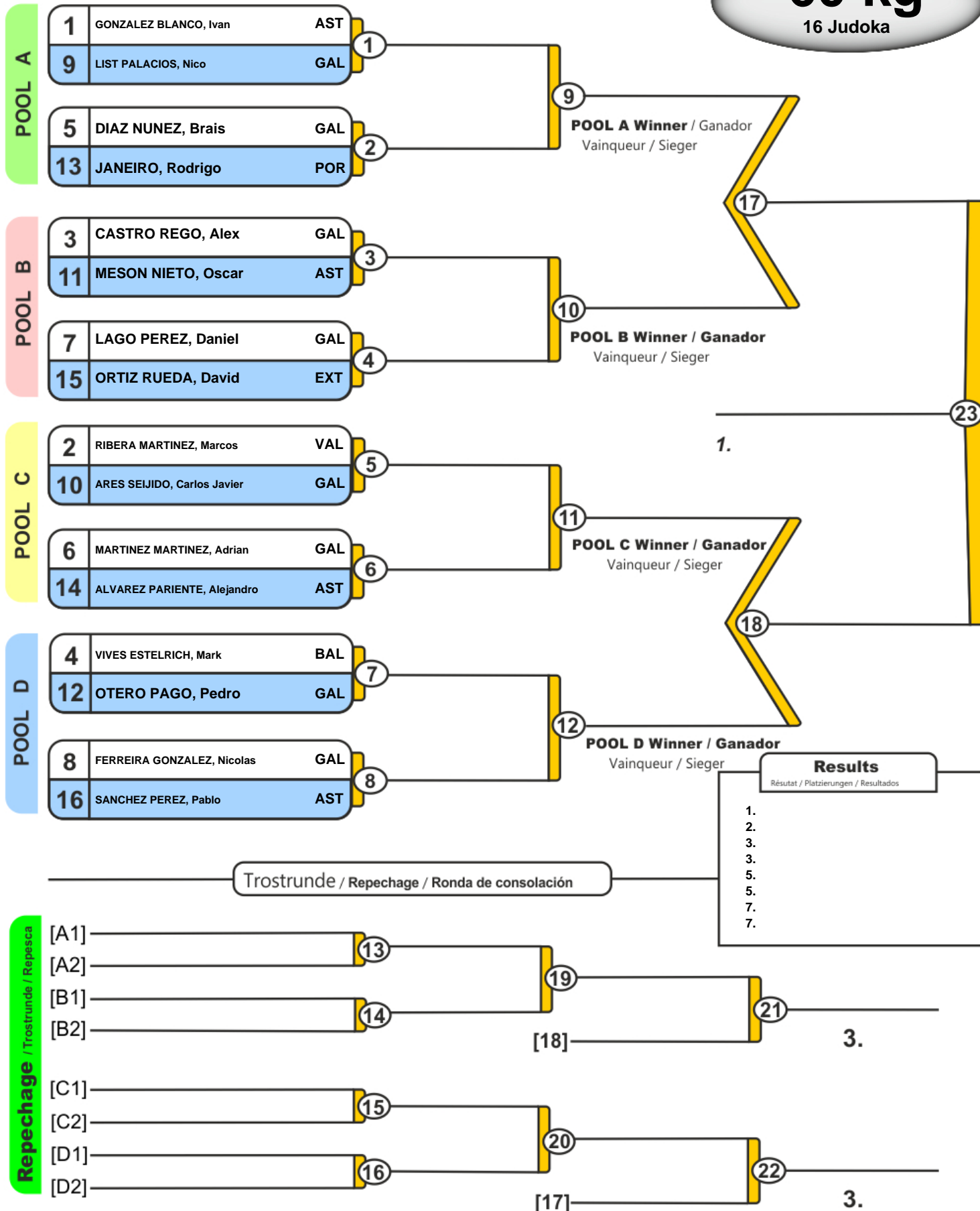



# Copa A de Espana Infantil Santiago 2020

Santiago (GAL), 01 Feb 2020

## -66 kg

11 Judoka

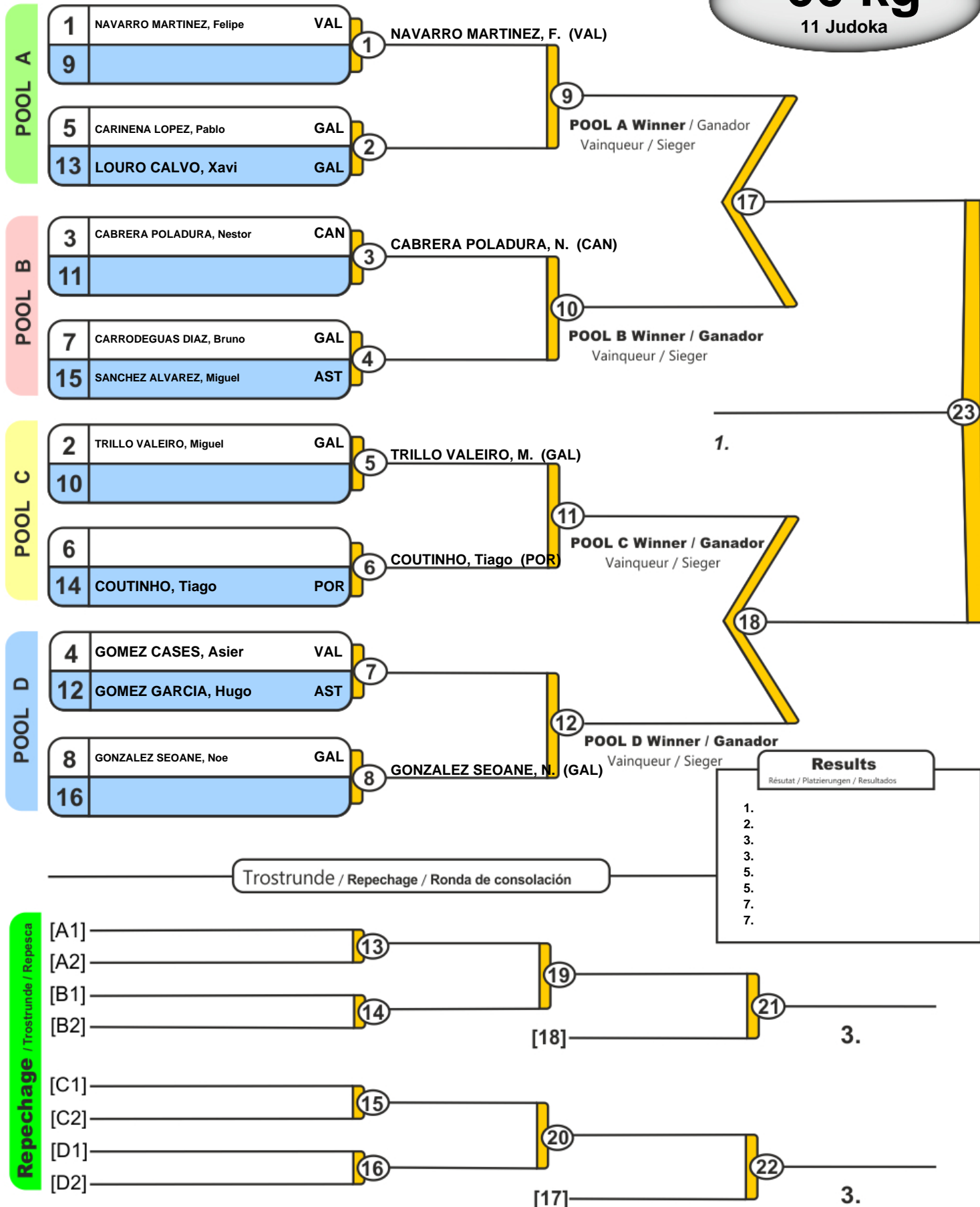

**+66 kg**  
7 Judoka

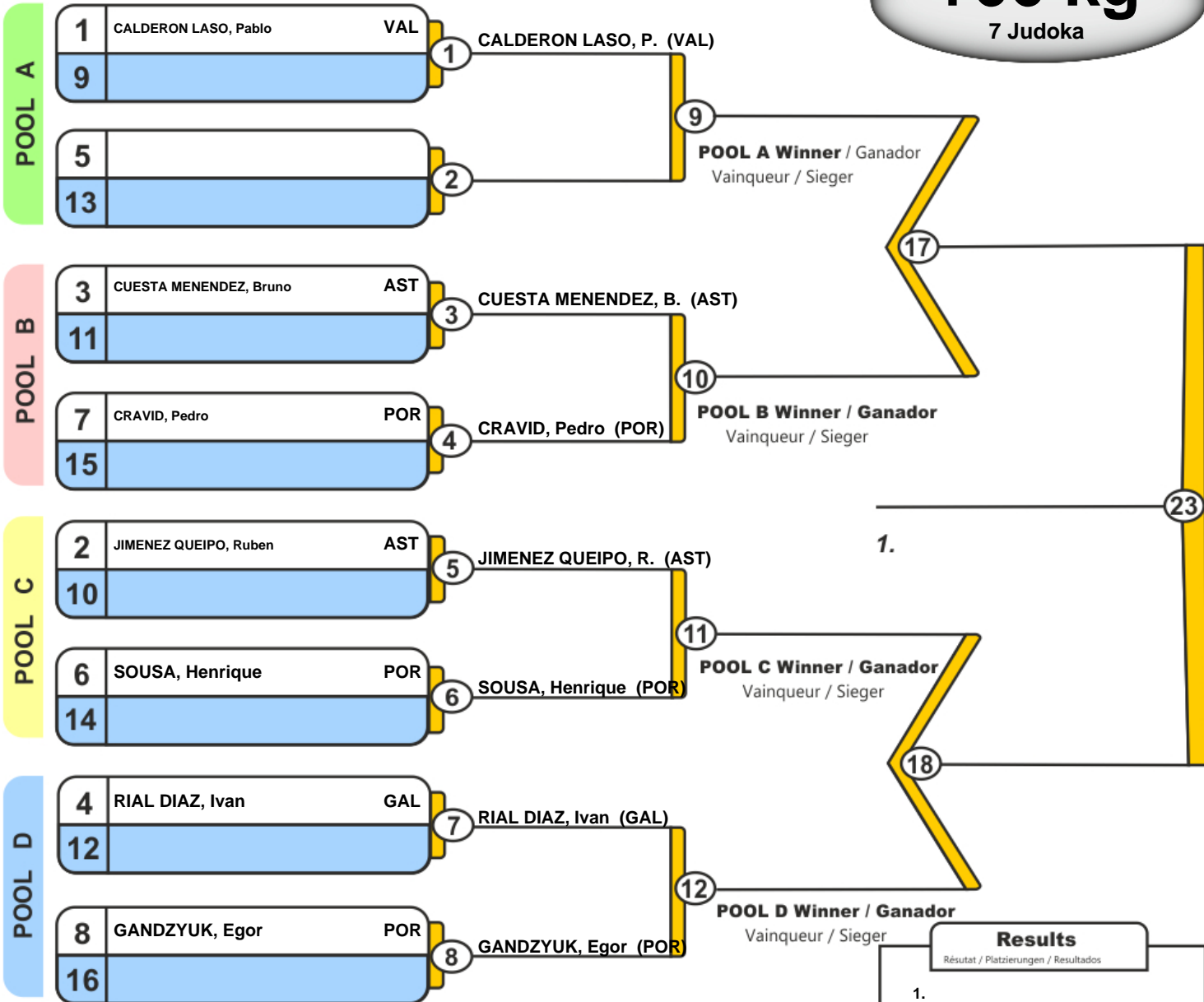

Trostrunde / Repechage / Ronda de consolación

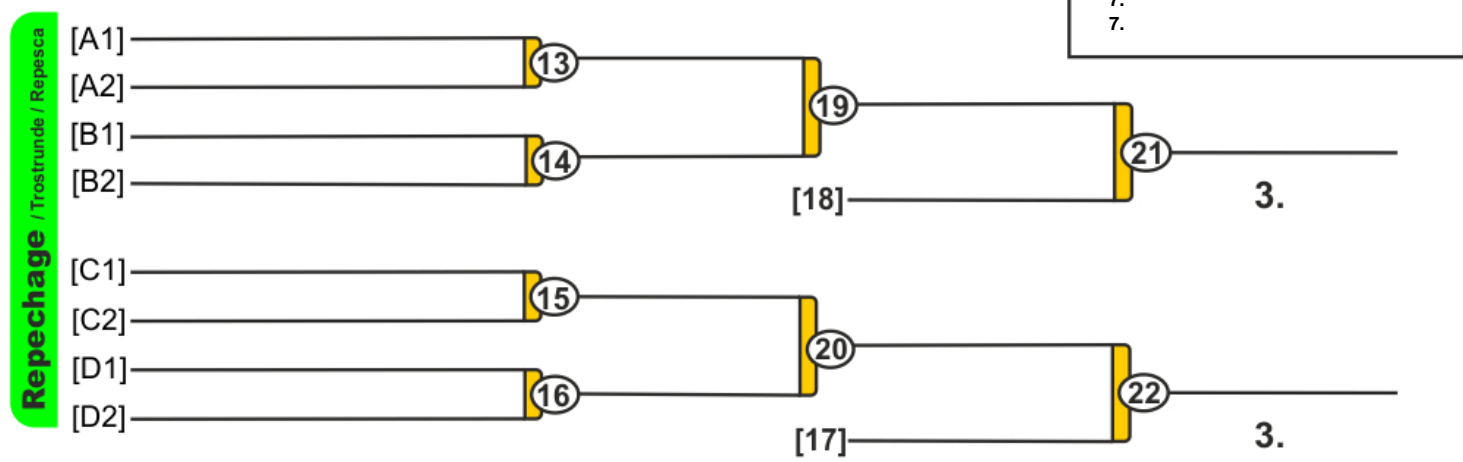

Results	
Résultat / Platzierungen / Resultados	
1.	
2.	
3.	
3.	
5.	
5.	
7.	
7.	





# Copa A de Espana Infantil Santiago 2020

Santiago (GAL), 01 Feb 2020

## -36 kg

6 Judoka

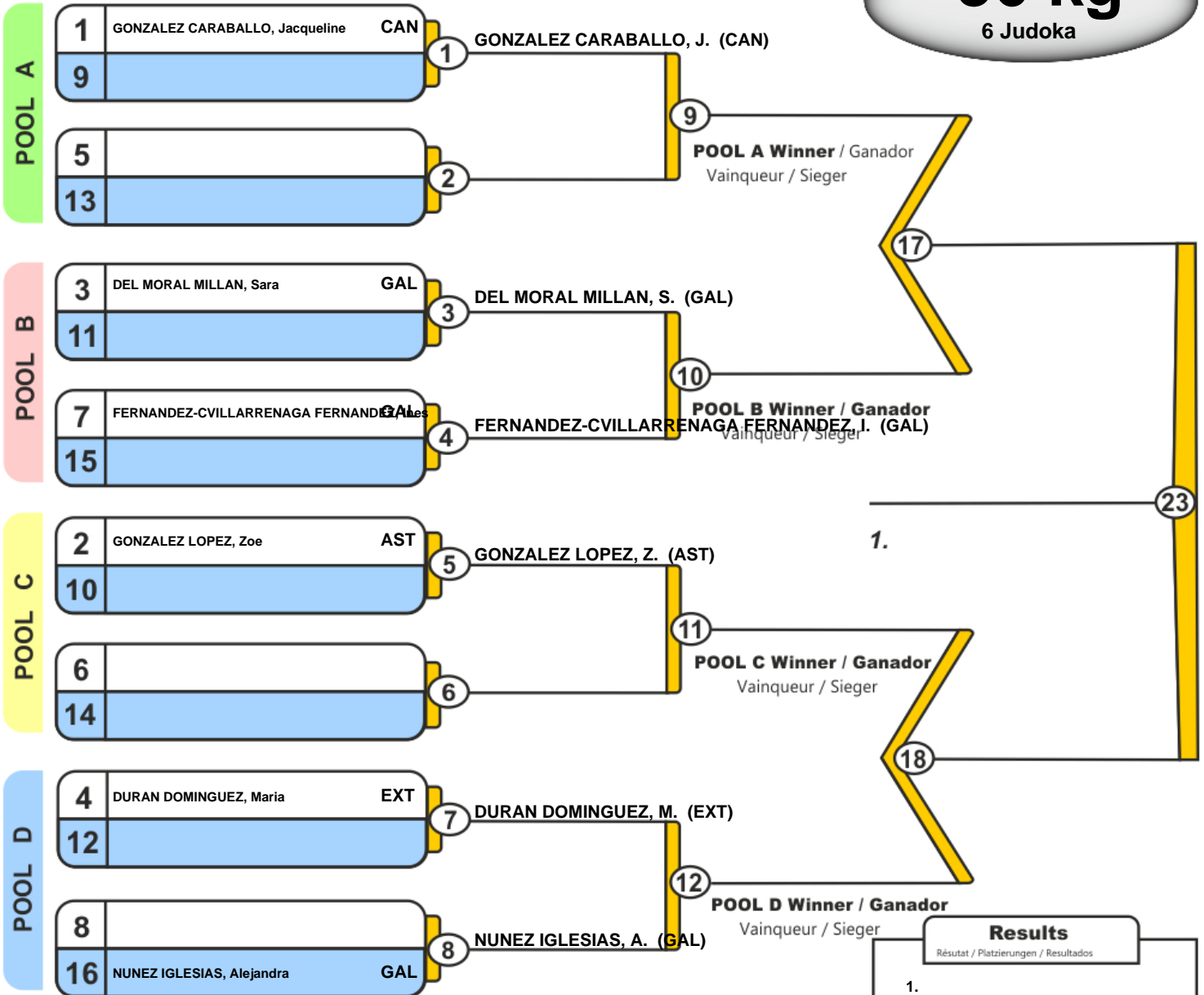

1.

Results	
Résultat / Platzierungen / Resultados	
1.	
2.	
3.	
3.	
5.	
7.	
7.	

Trostrunde / Repechage / Ronda de consolación

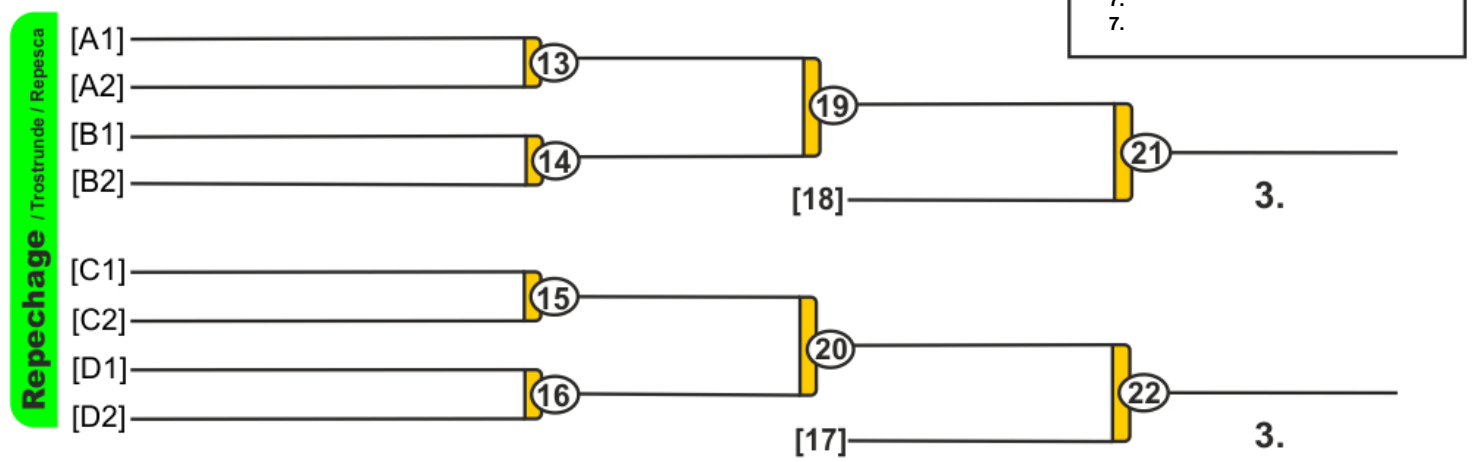

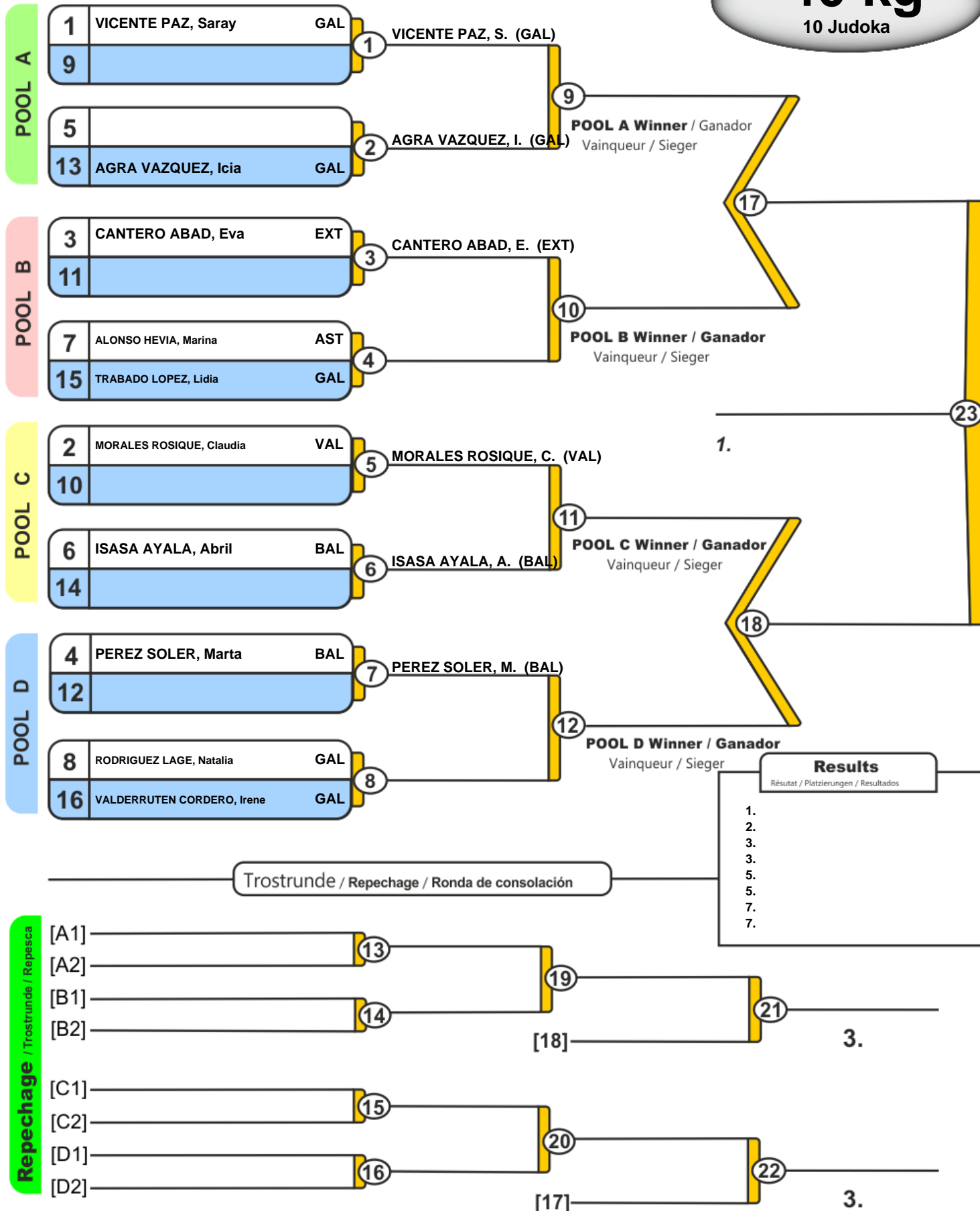



# Copa A de Espana Infantil Santiago 2020

Santiago (GAL), 01 Feb 2020

## -44 kg

13 Judoka

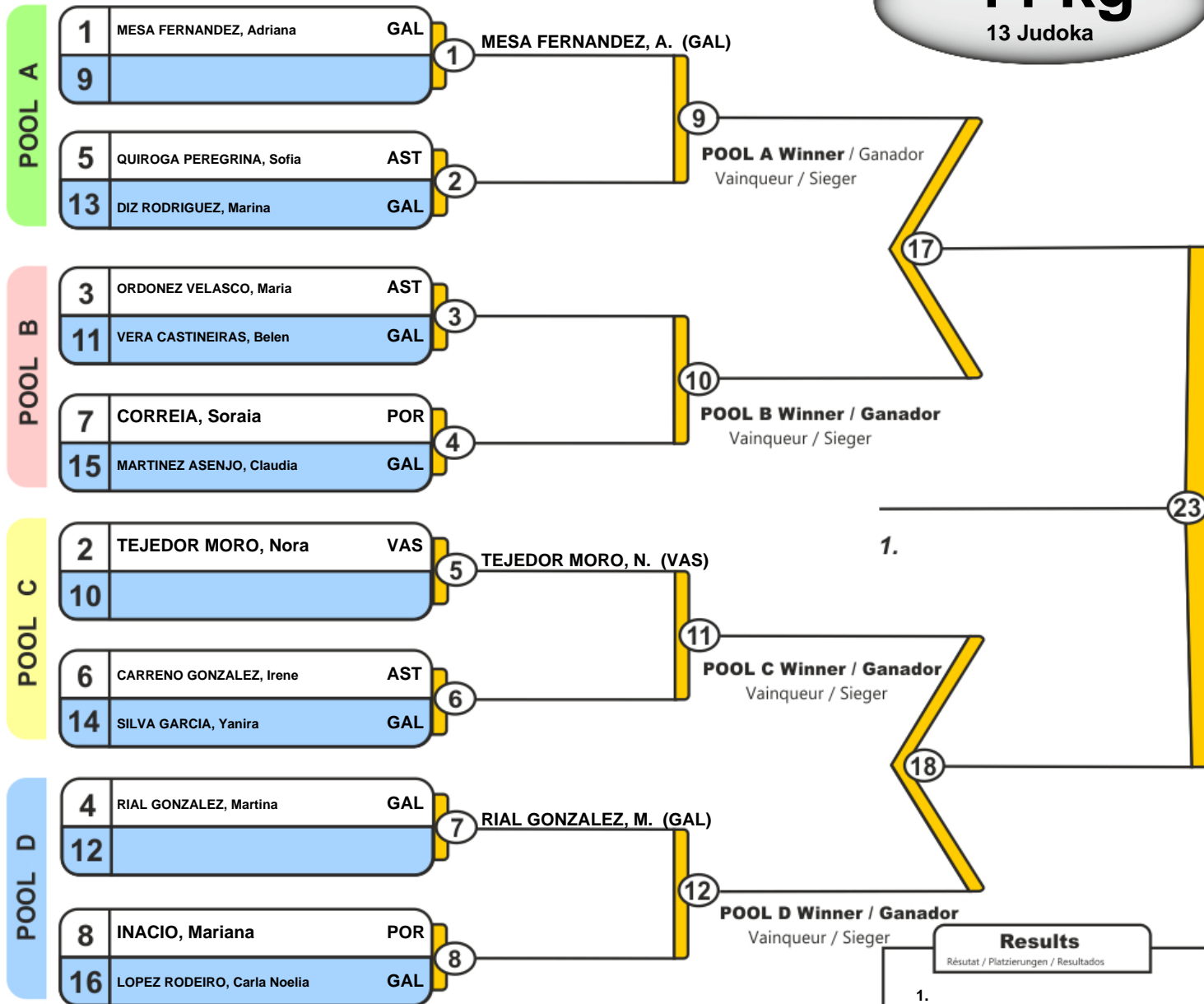

Trostrunde / Repechage / Ronda de consolación

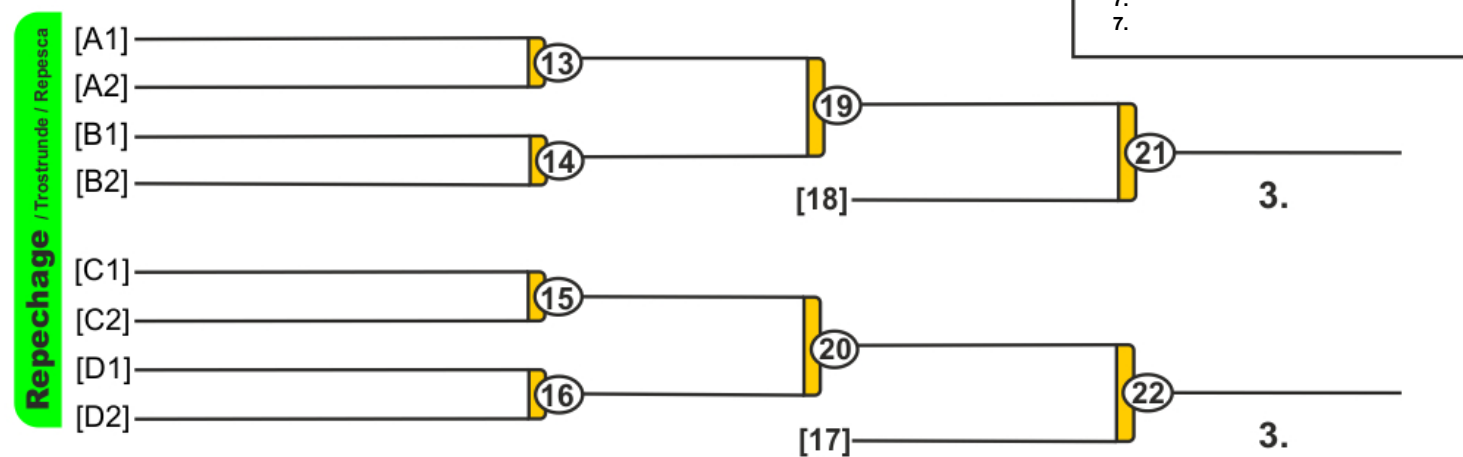

Results	
Résultat / Platzierungen / Resultados	
1.	
2.	
3.	
3.	
5.	
5.	
7.	
7.	



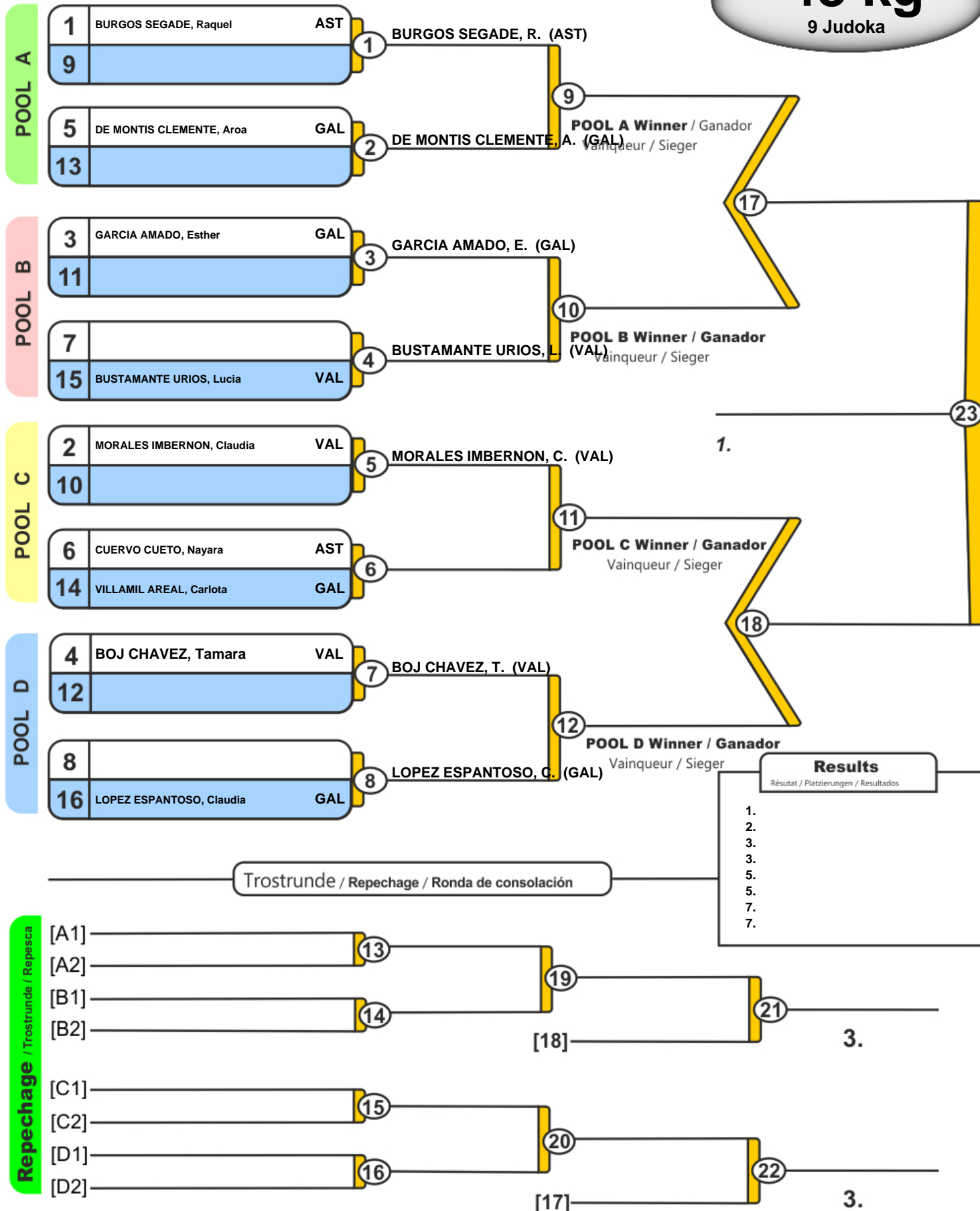



# Copa A de España Infantil Santiago 2020

Santiago (GAL), 01 Feb 2020

## -52 kg

14 Judoka

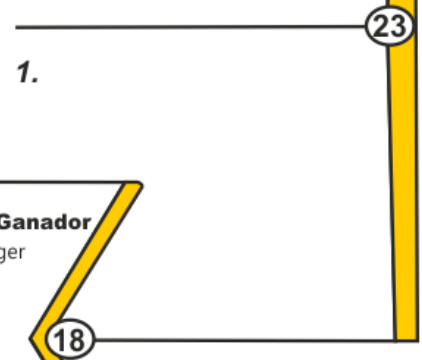
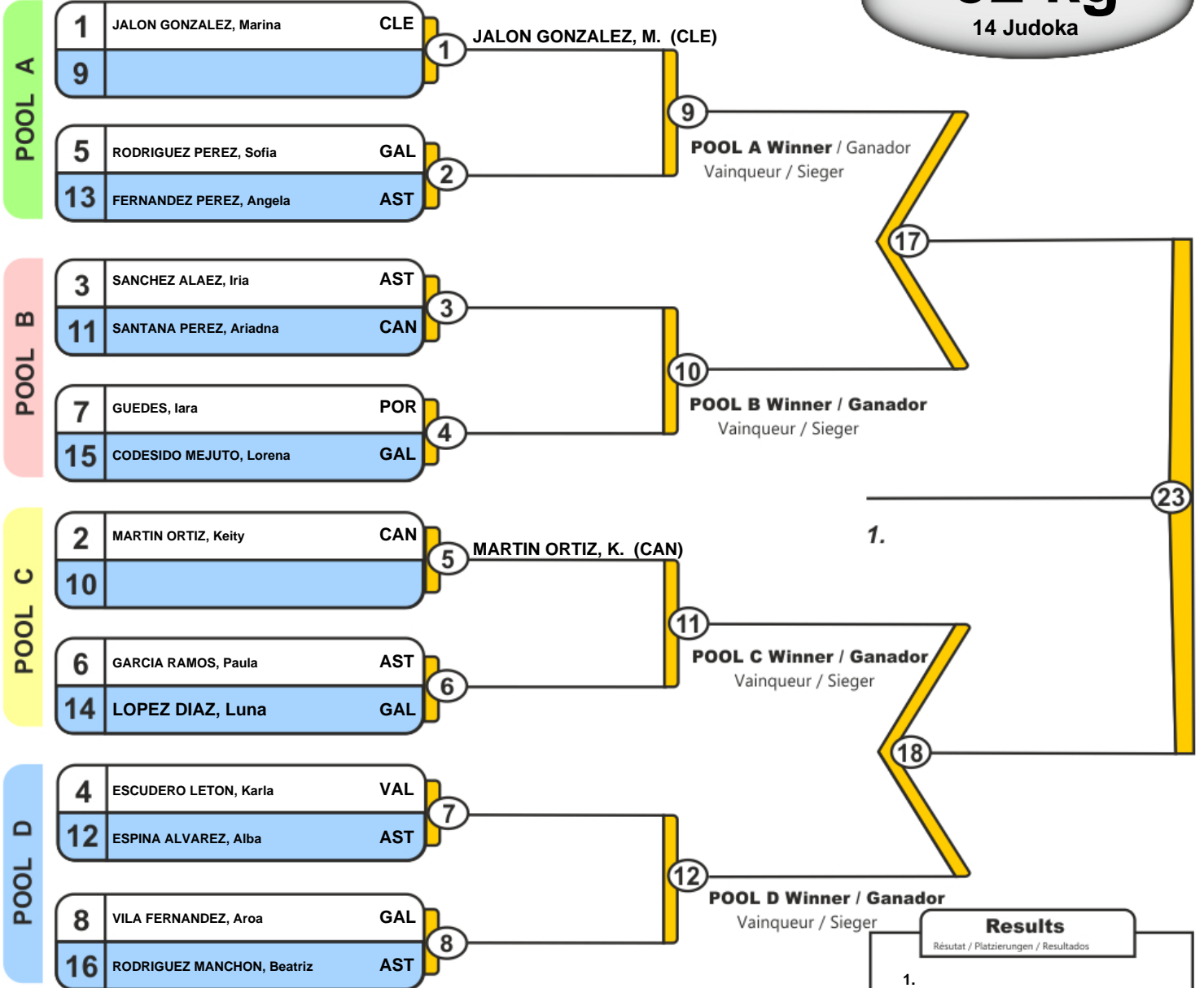

Trostrunde / Repechage / Ronda de consolación

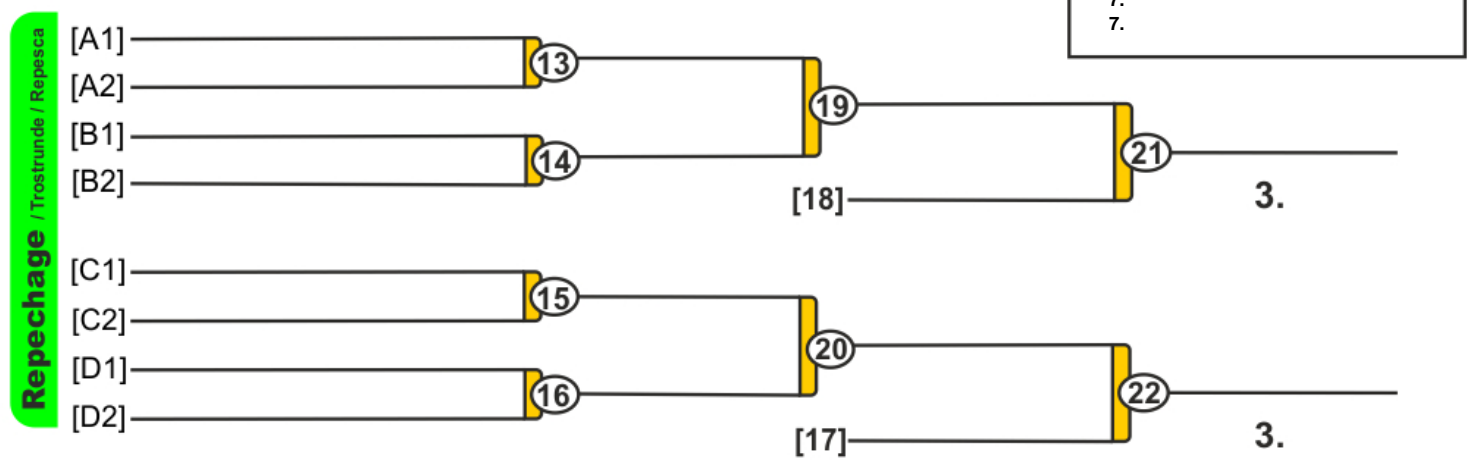

Results	
Résultat / Platzierungen / Resultados	
1.	
2.	
3.	
3.	
5.	
7.	
7.	



# Copa A de Espana Infantil Santiago 2020

Santiago (GAL), 01 Feb 2020

## -57 kg

11 Judoka

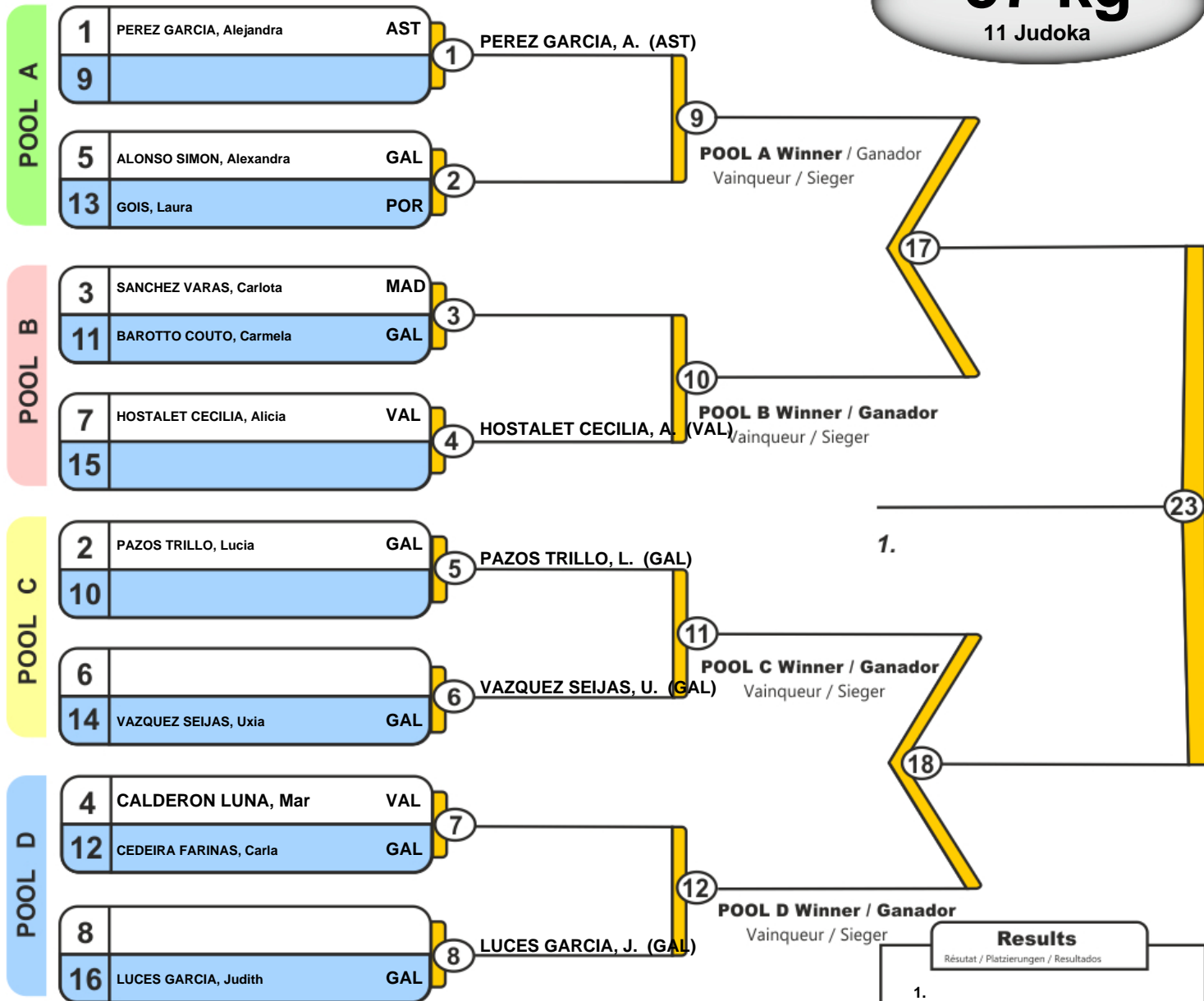

Trostrunde / Repechage / Ronda de consolación

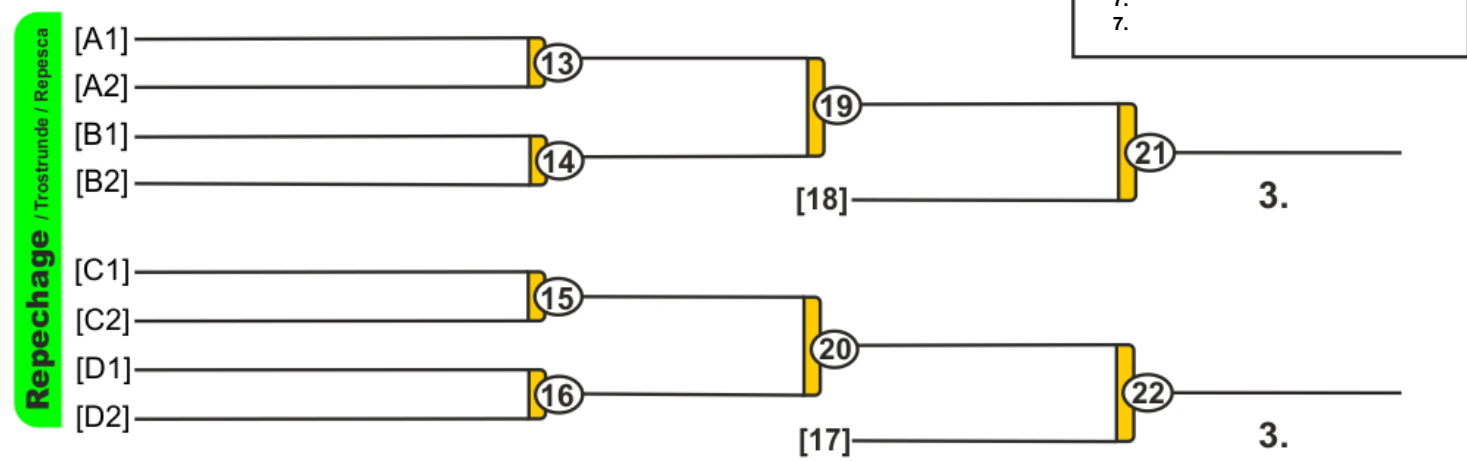

Results	
Résultat / Platzierungen / Resultados	
1.	
2.	
3.	
3.	
5.	
7.	
7.	



# Copa A de Espana Infantil Santiago 2020

Santiago (GAL), 01 Feb 2020

# -63 kg

2 Judoka

## Best of Three

1	ORDONEZ POZO, Sofia	VAL	1
2	FUENTES AFONSO, Rocio	GAL	

1	ORDONEZ POZO, Sofia	VAL	2
2	FUENTES AFONSO, Rocio	GAL	

1	ORDONEZ POZO, Sofia	VAL	3
2	FUENTES AFONSO, Rocio	GAL	



## Final Results

- 1.
- 2.



# Copa A de Espana Infantil Santiago 2020

Santiago (GAL), 01 Feb 2020

**+63 kg**  
7 Judoka

POOL A

1	HIJARRUBIA GONZALEZ, Sofia	CLE
9		

1 HIJARRUBIA GONZALEZ, S. (CLE)

5		
13	SANDINO RAMOS, Maika	GAL

2 SANDINO RAMOS, M. (GAL)  
**POOL A Winner / Ganador**  
Vainqueur / Sieger

POOL B

3	MUNIZ FERNANDEZ, Atenea	AST
11		

3 MUNIZ FERNANDEZ, A. (AST)

7	GONZALEZ UZAL, Noa	GAL
15		

4 GONZALEZ UZAL, N. (GAL)  
**POOL B Winner / Ganador**  
Vainqueur / Sieger

POOL C

2	TRUJILLO MENDEZ, Aisha	CAN
10		

5 TRUJILLO MENDEZ, A. (CAN)

6		
14	QUINTELA PRECEDO, Antia	GAL

6 QUINTELA PRECEDO, A. (GAL)  
**POOL C Winner / Ganador**  
Vainqueur / Sieger

POOL D

4	PORRAS GUTIERREZ, Natalia	GAL
12		

7 PORRAS GUTIERREZ, N. (GAL)

8		
16		

8  
**POOL D Winner / Ganador**  
Vainqueur / Sieger

Trostrunde / Repechage / Ronda de consolación

Repechage / Trostrunde / Repesca

[A1]		13
[A2]		19

[B1]		14
[B2]		21

[18] 3.

[C1]		15
[C2]		20

[D1]		16
[D2]		22

[17] 3.

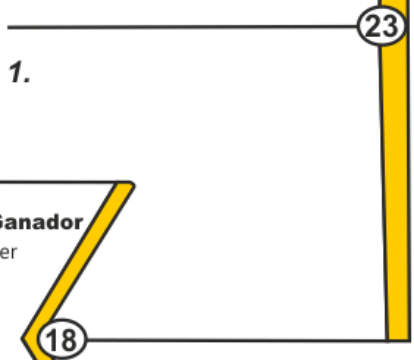

Results	
Résultat / Platzierungen / Resultados	
1.	
2.	
3.	
3.	
5.	
5.	
7.	
7.	

